



SICHUAN THZK TECH CO., LTD

📍 No. 469 north Qingyun Road, Xinjin District, Chengdu ,China

✉ Email: sales@thzkcon.com

🌐 <https://www.thzkcon.com/>

Traffic Baton & Warning Light

Be Seen Be Safer

— Product Manual —



SICHUAN THZK TECH CO., LTD is located in Tianfu Intel I igent Manufacturing Industrial Park, Chengdu, China. As a national high-tech enterprise, the company specialize in R&D, manufacture and sale electronic products. We can provide professional and efficient R&D electronic products, including Security Equipment, Communication Equipment, Electronic Testing Equipment, Instrument Control Equipment, High-rel iabi I ity Connectors, Optoelectronic Equipment, EMC equipment, Integrated Circuit Development, Software Programming and etc.; As the pioneer of the airport high-rel iabi I ity, drop-proof and waterproof baton, our products have been sold over one million units and exported to European and American multi-national.

After years of accumulation and development, the company has been granted ISO9001 and IATF16949 quality system certificates, meanwhile approved as a national high-tech enterprise. With more than 30 national invention and uti I ity model patents, the products have been approved various professional certifications, such as EX , CE etc.

We have a professional R&D team, adhering to the development philosophy of gratitude, cooperation, precision and dedication. Striving to provide customers with more stable, reliable, safe and durable quality products. We wi ll continue to innovate and make breakthrough, actively study and expand into new field.



The pioneer of airport
anti-fall and waterproof baton

Sales over **one million** units





Contents

- ◆ Product Description 01
- ◆ Product List 03
- ◆ Application 06
- ◆ L8960 Airport LED Traffic Baton 07
- ◆ L9060 Traffic LED Safety Baton 15
- ◆ L9210 Multifunctional Warning Light 21
- ◆ L9100 Portable Explosion-proof Warning Light 37
- ◆ L9500 Flashing Traffic Baton 45
- ◆ DAY WAND 55



Product Description

LED traffic batons and warning lights, can be used in traffic control, airport, marine, outdoor, emergency rescue and anywhere require warning, which is high-visibility, waterproof, dust-proof, drop resistant and anti-rust, as well as a flexible modes to select, it is a powerful guarantee for your safety. With the functions of steady-on, flash, magnetic, flashlight and etc.



High-visibility



Long Battery Life



Multiple Modes



Easy to Operate



Waterproof&Dust-proof



Drop resistant



Anti-rust



Anti-high and low TEMP



Portable



Non-Slip Handle



Beautiful and Useful



Customized

Traffic Baton/Warning Light Series

Ingenuity Quality ; Night Partner, Safe Life



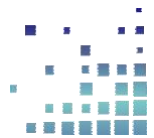

Product List

Airport LED Traffic Baton

Drop-proof
Waterproof
High Brightness

L8960
L8960R
L8961



L8962
L8963
L8964
L8965
L8966
L8967



L8968
L8969



Traffic LED Safety Baton

Drop-proof
Waterproof
Anti-high and low
TEMP
Anti-Corrosion

L9030
L9031



L9032
L9033
L9034
L9035
L9036
L9037
L9040
L9041



L9038
L9039



Flashlight Traffic Baton

Drop-proof
Waterproof
High Brightness

L9500A/R



L90510A/R

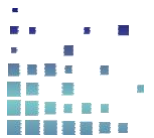

Product List

Multifunctional Warning Light

Multifunctional
High Brightness Drop-
proof Waterproof

L9210R1
L9210B1
L9210Y1
L9210G1
L9210RB1
L9210R2
L9210B2
L9210Y2
L9210G2
L9210RB2



Portable Explosion-proof Warning Light

High Brightness
Anti-Corrosion
Explosion-proof
Portable

L9100R



Portable Explosion-proof Warning Light

High Brightness
Anti-Corrosion
Explosion-proof
Portable

L9100Y



L9100B



L9100G







L9100RB





Product List

<p>DAY WAND</p> <p>Ultra-lightweight Anti-high and lowTEMP Drop-proof</p>	 <p>L9081</p>		
<p>End cap</p> <p>Waterproof Anti-roll Magnetic</p>			
<p>Anti-drop lanyard</p> <p>Portable</p>		<p>Rubber Base</p> <p>Wear-resistant Durable Anti-aging Portable</p>	

Application

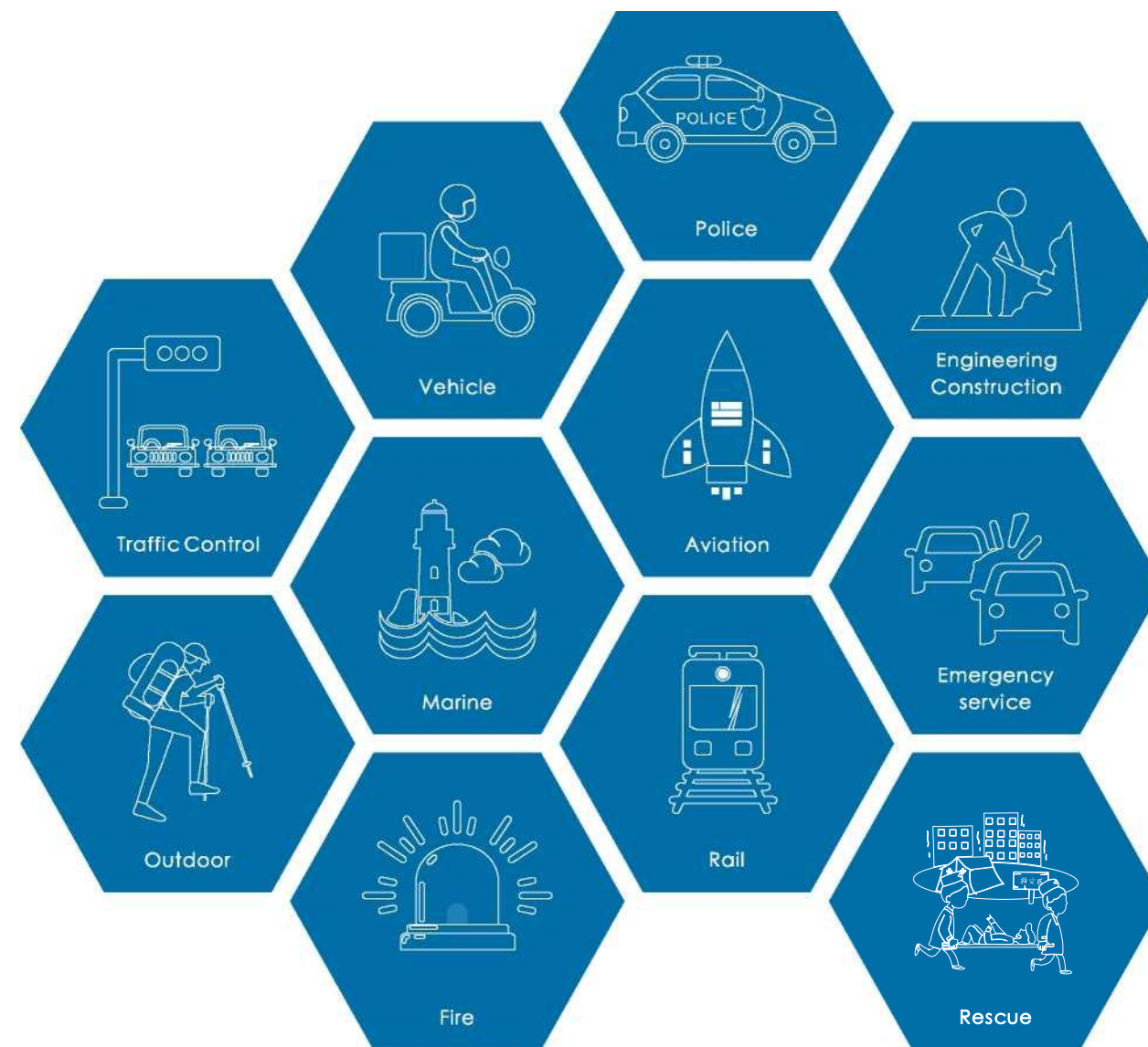

Airport LED Traffic Baton

Drop-proof, Waterproof, High-visibility LED traffic baton can be seen at a distance of more than 1 km at night.



Product structure

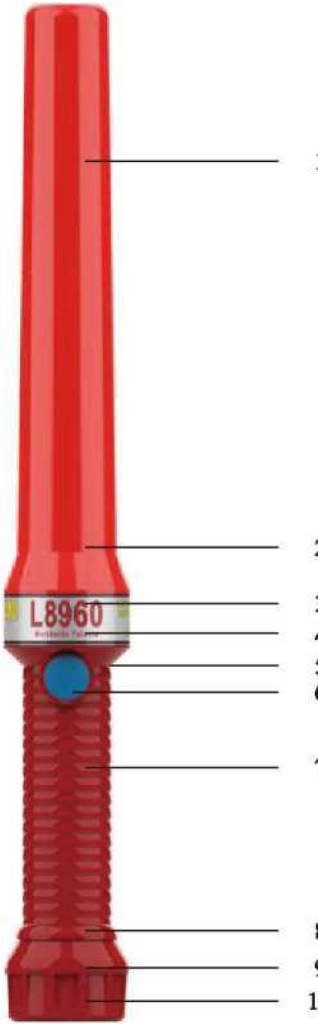







	1	1. Enhanced tube
	2	2. Anti-shock and anti-corrosion PCB
	3	3. Reflective label
	4	4. Ultrasonic welding
	5	5. PCB protection structure
	6	6. Waterproof switch , Protection Level Ip67
	7	7. Non-Slip Handle
	8	8. Waterproof seal ring , Protection Level IP67
	9	9. Stainless steel components , anti-corrosion and anti-rust
	10	10. Waterproof end cap , Protection Level Ip67

Specification

Product Name	Airport traffic baton	Number of Lamp	1 LED light
Diameter	ø40mm	Body Color	Red / White / Yellow
Length	360mm	Visible Color	Red / Green / Blue/ Yellow
Weight	150g(without battery)	Visible Distance	>1Km
Battery Type	2 Alkaline C Cell Batteries	LED Lifetime	>100000h
Battery Life	N100h(Keep Working)	Protection Level	Ip67
Working Voltage	1.9V-3.2V	Certification	CE
Working Current	80mA-150mA	Patent No.	ZL201430017594.8
Quiescent Current	<5 μA	Packing	20pcs/box , 100pcs/carton
Working Temperature	-30°C~80°C	Carton Infb	470*360*450mm



Models

	Function	Model	LED color	
	Glow Red - OFF	L8960		
	Fast Flash - Slow Flash - Glow Red - OFF	L8961		
	Glow Green - OFF	L8962		
	Fast Flash - Slow Flash - Glow Green - OFF	L8963		
	Glow Red & Green - OFF	L8964		
	Glow Red & Green - OFF; Slow Flash Red & Green (3S) - OFF; Fast Flash Red & Green (5S) - OFF;	L8965		
	Glow Blue- OFF	L8966		
	Fast Flash-Slow Flash-Glow Blue -OFF	L8967		
	Glow Yellow - OFF	L8968		
	Fast Flash-Slow Flash-Glow Yellow - OFF	L8969		

Enhanced tube,
anti-shock and
anti-corrosion PCB

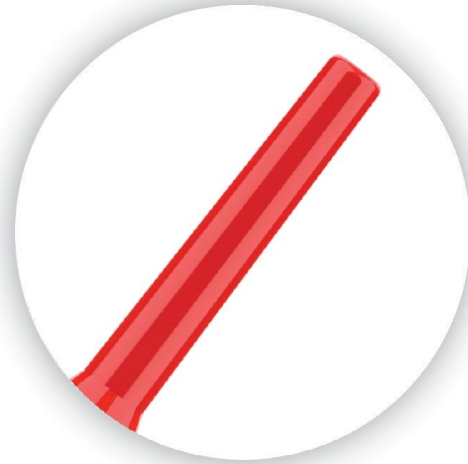

Waterproof switch,
protection level IP67



Non-slip handle, anti-rust



Optional end cap with
portable rope

PCB protection structure,
prevent corrosion of circuit
boards from battery
leakage

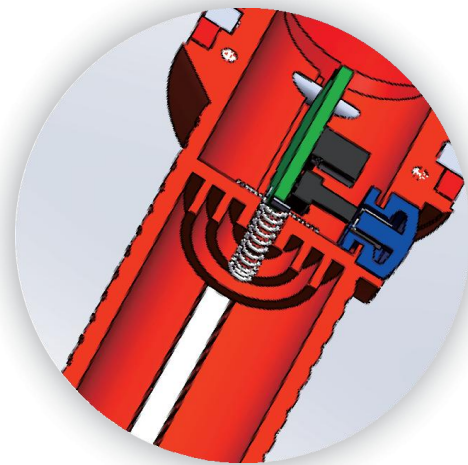

Adapt to extreme
environments of
-40~+85°C

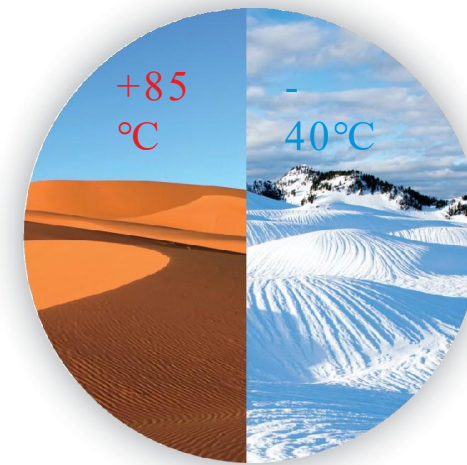



Traffic LED Safety Baton
Drop-proof, Waterproof, Anti-high and low temperature, Anticorrosion, High-visibility Traffic LED Safety Baton can be seen at a distance of more than 1 km at night.



Product structure

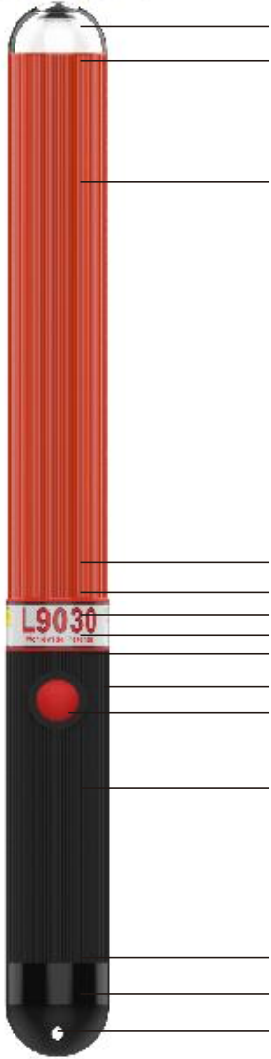









	1	1. High transparent lamp holder
	2	2. Waterproof seal ring , Protection Level IP67
	3	3. Enhanced stripe tube
		4. Reflector Cup
		5. Waterproof seal ring , Protection Level IP67
		6. Threaded assembly, easy to disassemble
		7. Reflective label
	4	8. Anti-shock and anti-corrosion PCB
	5	
	6	9. PCB protective card cup
	7	
	8	
	9	10. Waterproof switch, Protection Level IP67
	10	
11	11. Non-Slip Handle	
	12. Waterproof seal ring , Protection Level IP67	
12	13. Stainless steel components, anti-corrosion and anti-rust	
13		
14	14. Anti-drop lanyard hole	

Specification

Product Name	Traffic LED Safety Baton	Number of Lamp	1 LED light/RGB
Diameter	ø40mm	Body Color	Red / White / Yellow
Length	400mm	Visible Color	Red / Green / Blue/ Yellow
Weight	230g(without battery)	Visible Distance	>1Km
Battery Type	2 Alkaline C Cell Batteries	LED Lifetime	>100000h
Battery Life	N100h(Keep Working)	Protection Level	Ip67
Working Voltage	1.9V-3.2V	Certification	CE
Working Current	80mA-150mA	Patent No.	ZL201430017594.8
Quiescent Current	<5 μA	Packing	1pcs/box , 50pcs/carton
Working Temperature	-30 ℃~80℃	Carton Infb	500*440*280mm



Product Models

	Function	Model	LED color
	Glow Red - OFF	L9030	
	Glow Red - OFF ; Slow Flash (3S) - OFF; Fast Flash (5S) - OFF	L9031	
	Glow Green - OFF	L9032	
	Glow Green - OFF ; Slow Flash (3S) - OFF; Fast Flash (5S) - OFF	L9033	
	Glow Red & Green - OFF; Slow Flash(3S) - Fast Flash Red(5S) - OFF; Slow Flash(3S) - Fast Flash Green(5S) - OFF;	L9034	
	Glow Red & Green - OFF	L9035	
	Glow Blue - OFF	L9036	
	Glow Blue - OFF ; Slow Flash(3S)- OFF; Fast Flash(5S) - OFF;	L9037	
	Glow Red & Green & Blue - OFF; Slow Flash(3S) - Fast Flash Red(5S) - OFF; Slow Flash(3S) - Fast Flash Green(5S) - OFF; Slow Flash(3S) - Fast Flash Blue(5S) - OFF;	L9040	
	Glow Green & Yellow & Red -OFF	L9041	
	Glow Yellow - OFF	L9038	
	Glow Yellow - OFF; Slow Flash(3S) - OFF; Fast Flash(5S) - OFF;	L9039	

Features

High performance LED lamp beads, operating life $\geq 100,000$ hours



Double sealing leakproof switch design with patent grant, IP67 waterproof



High light transmission top cap for use in emergency lighting



Heat resistance, UV resistance, shock resistance, rubber coated handle

Impact resistance, acid and alkali resistance, stronger light penetration

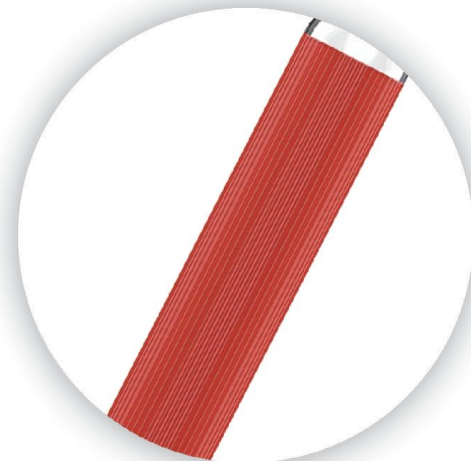

Adapt to extreme environments of $-40\sim+85^{\circ}\text{C}$

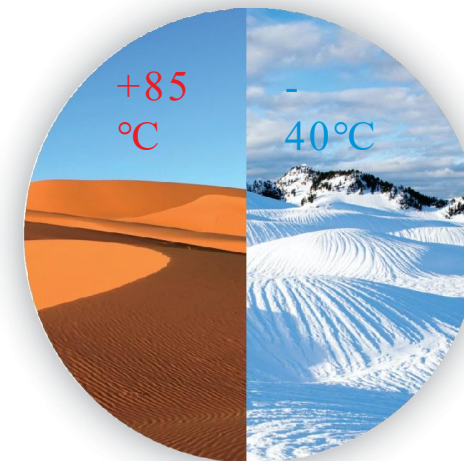

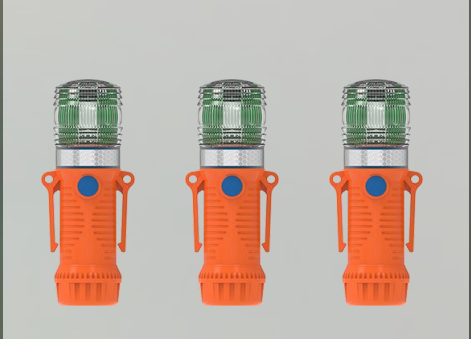
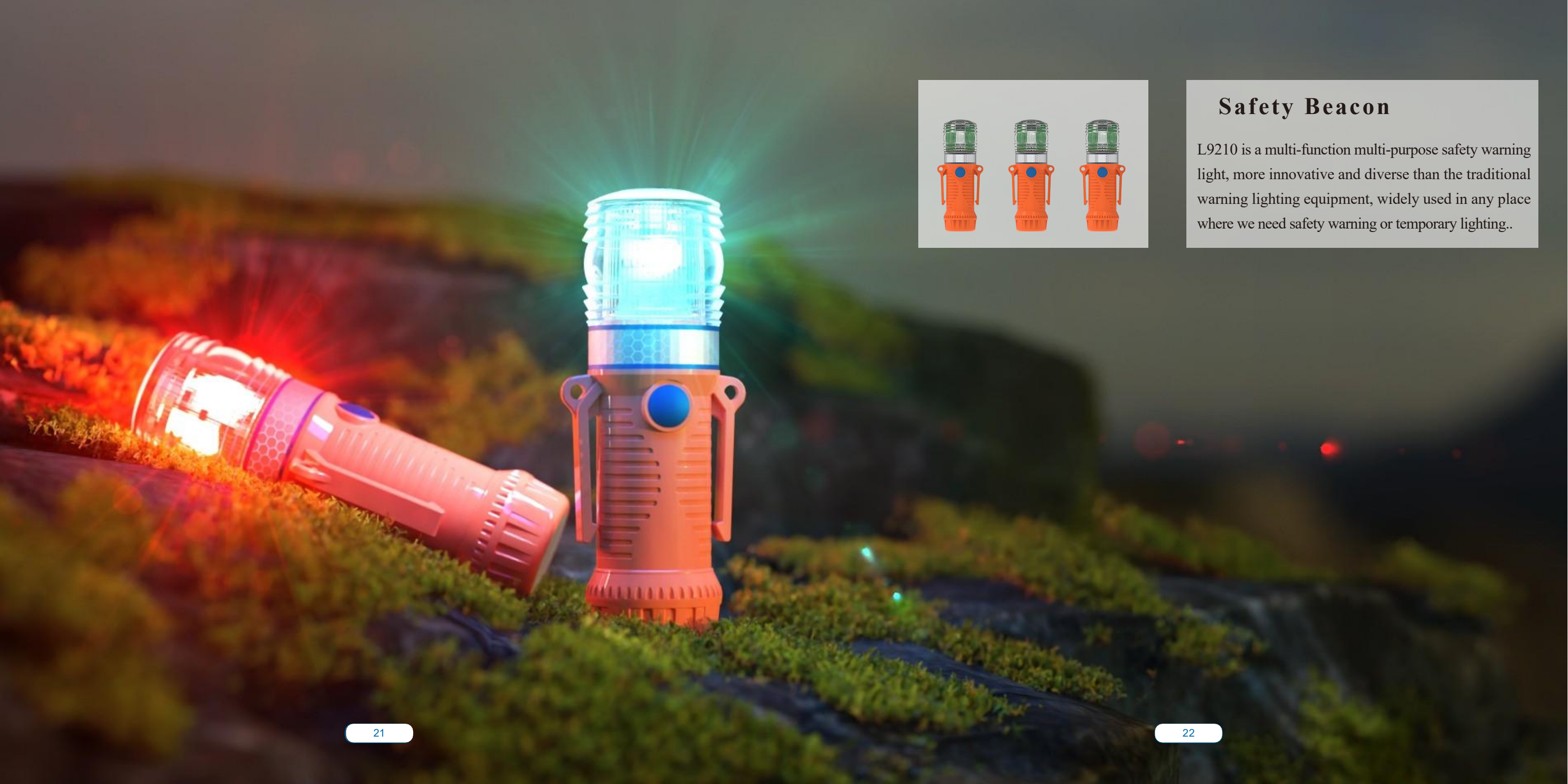

Safety Beacon

L9210 is a multi-function multi-purpose safety warning light, more innovative and diverse than the traditional warning lighting equipment, widely used in any place where we need safety warning or temporary lighting..

Product structure

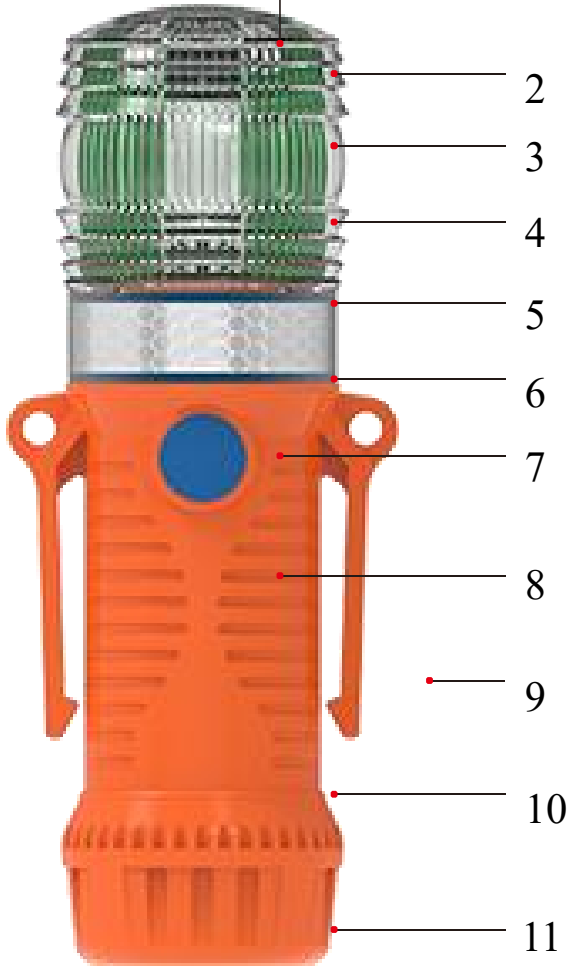
	1	1. High power explosive LED, high brightness and long range
	2	2. High-brightness LED lights, Visible Distance > 1Km
	3	3. PCB three anti-treatment, anti-corrosion and durable
	4	4. High strength transparent PC, enhance the product light transmittance
	5	5. Lattice Reflective label
	6	6. PCB protection structure, Prevent corrosion of the circuit board due to battery leakage
	7	7. Silicone switch, waterproof and durable
	8	8. Built-in battery protection box, shock proof (powered by 5000mAh large capacity lithium battery)
	9	9. High strength side clamp, can be arbitrarily suspended
	10	10. Silicone O- seal ring , Waterproof&Protection Level IP68
	11	11. Standard round end cup (Optional Magnet end cup)

Specification

Product Name	L9210 Multifunctional Warning Light	Patent No.	ZL 2021 3 0705273.7
Visible Distance	> 1Km	Product Color	ABS Yellow&Green Handle+ Imported high penetration PC
Battery Type	4 AA batteries /1 lithium #26650 battery optional	Led Color	Optional
Battery Life	> 30h	Illumination Color	White Light (1W)
Working Voltage	2.5V-6V	Led Life	> 50k h
Working Current	90mA-450mA	Length	165mm
Quiescent Current	< 5μA	Weight	190g (without battery)
Working Temperature	-40~+85°C	Protection Level	IP68



Construction



Fog Homework



Transport Warning



Emergency Lighting



Traffic Control

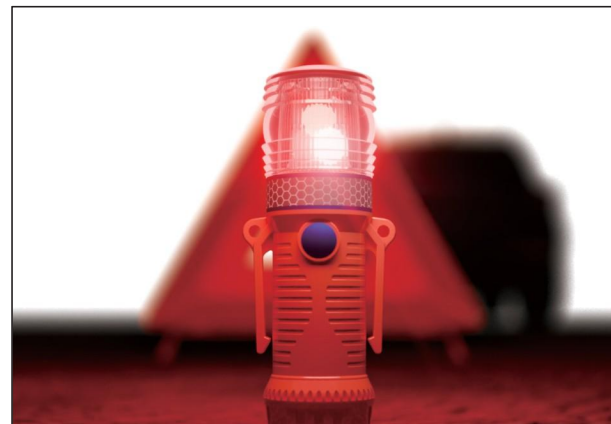

Emergency Situation



Outdoor Field Trip



Construction of Warning

Product Features

High performance LED,
1w lamp beads, working
life $\geq 100,000$ hours



Type-C
charging interface, Security firm
(Suitable for 5V1A charger)



Alternative end cap, can be
matched according demands



Multifunctional side clip,
convenient and durable, stable
clamping force

Reflective label, more
visible at night



White light illumination, can
be used as emergency
lighting

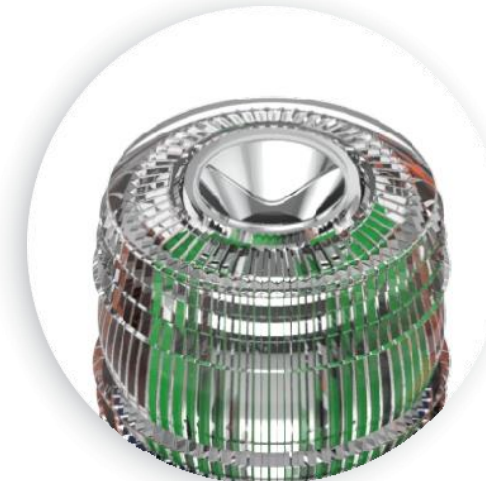





Steady on: up to **15_h**

Flash (3Hz): up to **30_h**

Long battery life



Protection Level **IP68**
water resistance



Multiple placement modes

Can be used different placement methods based on application scenarios

Magnet

Up-right

Side clip

Suspend



Optional Accessories



- Standard round end cup



- Magnet end cup: $\Phi 30 \times 2.5 \text{mm}$
Magnet embedded in plastic case, PVC label protection, wear and durable



- Rubber base: wear-resistant and durable, which can support the stable arrangement of products on the ground

Battery Assembly Diagram

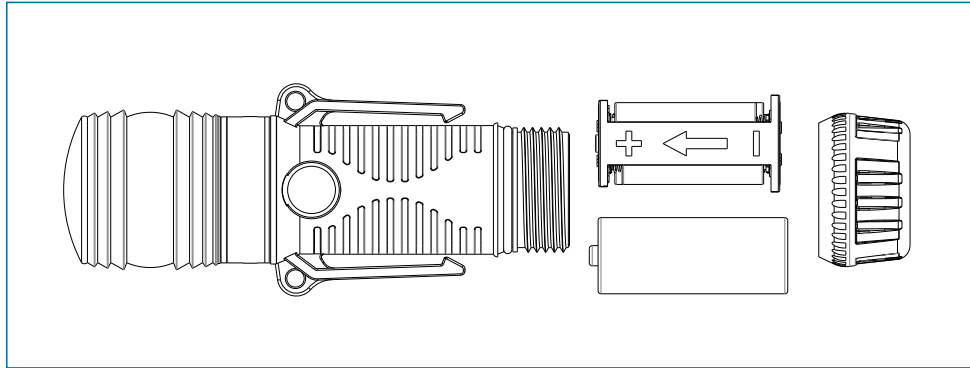



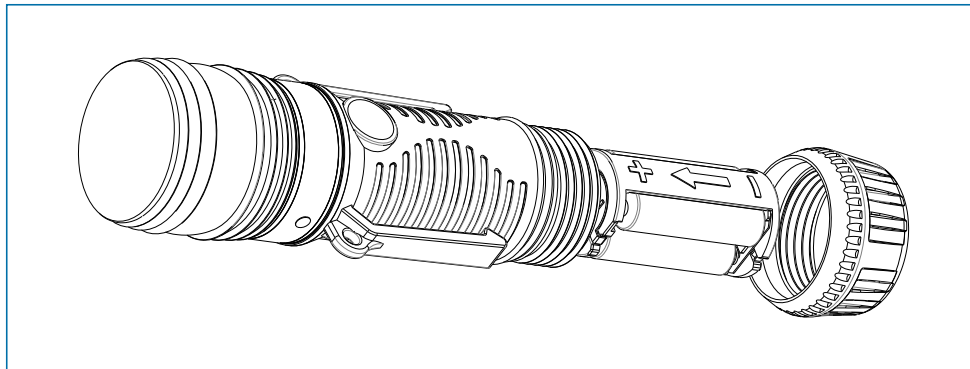









Rotate the bottom rear cover, press to remove the battery box (dry battery/lithium battery):



Install 4 AA batteries / 1 lithium #26650 battery optional according to the positive and negative electrodes, pull out the battery and take the septum before use, and rotate the bottom end cup to the seamless state.

L9210 Series Models

Picture	Function	Battery Type	Model	LED color
	Flash - Glow Red - Steady on - OFF;		L9210R1	
	Flash - Glow Yellow - Steady on - OFF;		L9210Y1	
	Flash - Glow Blue - Steady on - OFF;		L9210B1	
	Flash - Glow Green- Steady on - OFF;		L9210G1	
	Flash - Glow Red&Green- Steady on - OFF;		L9210RB1	
	Flash - Glow Red - Steady on - OFF;		L9210R2	
Flash - Glow Yellow - Steady on - OFF;	L9210Y2			
Flash - Glow Blue - Steady on - OFF;	L9210B2			
Flash - Glow Green- Steady on - OFF;	L9210G2			
Flash - Glow Red&Green- Steady on - OFF;	L9210RB2			

Portable Explosion-proof Warning Light

Strong light flashing, small volume, light weight,
multiple carrying methods portable, Protection
Level IP67, can work normally under water.

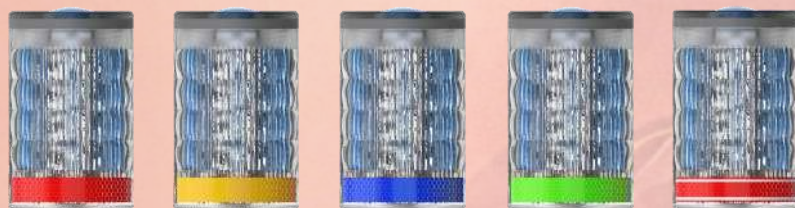

Product structure

	1. IP67 Waterproof switch, Protection Level Ip67
	2. IP67 Waterproof seal ring, Protection Level Ip67
	3. High-brightness LED lights with various function
	4. Polygonal spotlight lens
	5. Magnetic
	6. Multi-function clip
	7. Reflective label

Specification

Product Name	Portable Explosion-proof Warning Light	Working Temperature	•45°C ~12(TC
Size	72*46*39mm	Light Cover Color	Transparent color
Weight	100g(without battery)	Visible Light Color	Red / Yellow / Blue / Green
Battery Type	2 Alkaline C Cell Batteries	Visible Distance	>1Km
Battery Life	> 100 Hours (Keep Working)	Fast-flash	1Hz
Working Voltage	DC3V	Slow-flash	4Hz
Quiescent Current	<3 JA	Protection Level	Ip67

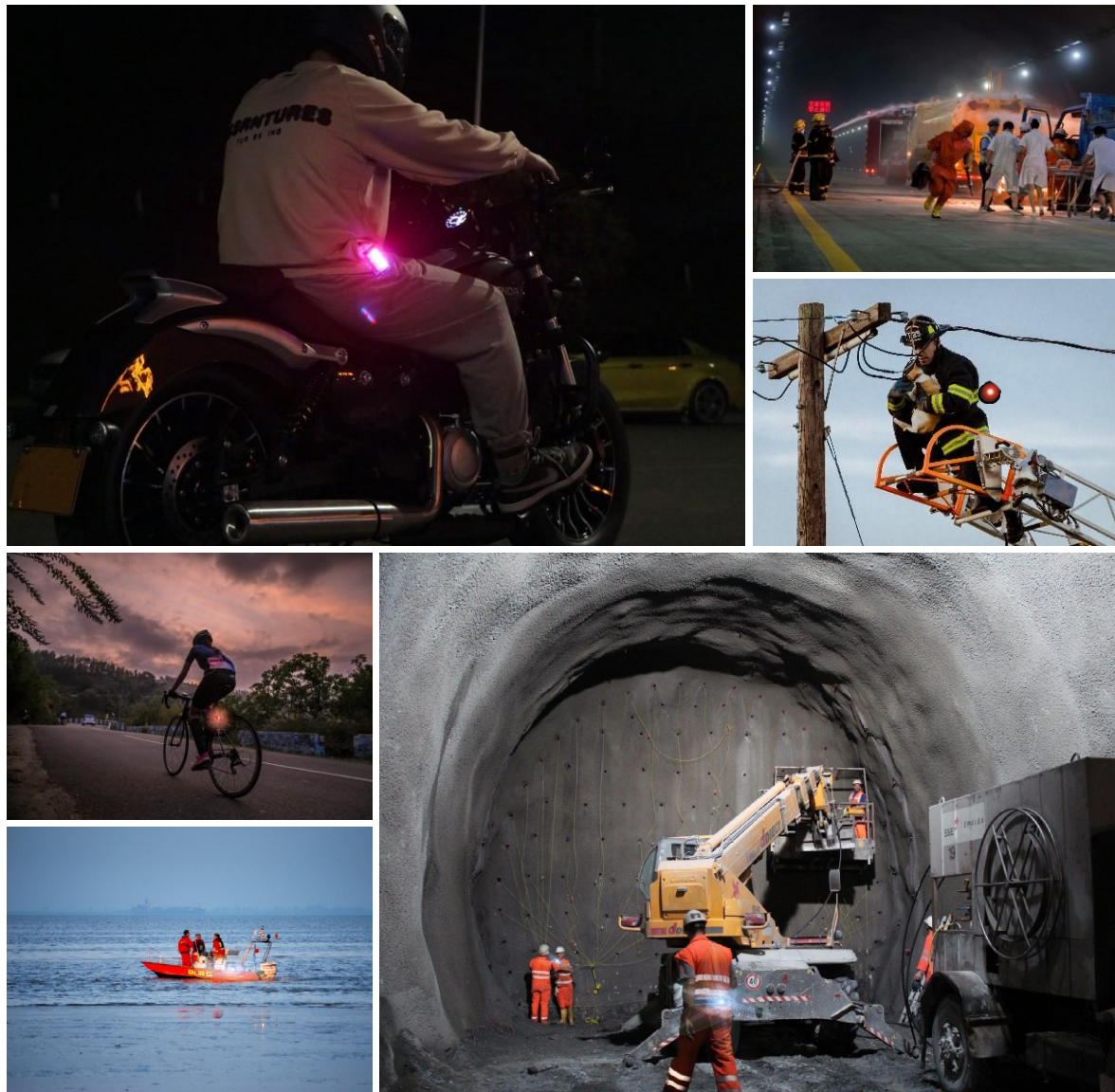

Product Model

Picture	Function	Model	LED color
	Glow Red - Slow Flash - Fast Flash	L9100	●
	Customized	L9101	
	Glow Blue - Slow Flash - Fast Flash - OFF	L9102	●
	Customized	L9103	
	Glow Green - Slow Flash - Fast Flash	L9104	●
	Customized	L9105	
	Glow Yellow - Slow Flash - Fast Flash	L9106	●
	Customized	L9107	
	Glow red & Green - OFF; Slow Flash Red & Green (3S) - OFF; Fast Flash Red & Green (5S) - OFF;	L910	●

Features

Waterproof switch
& seal ring, IP67

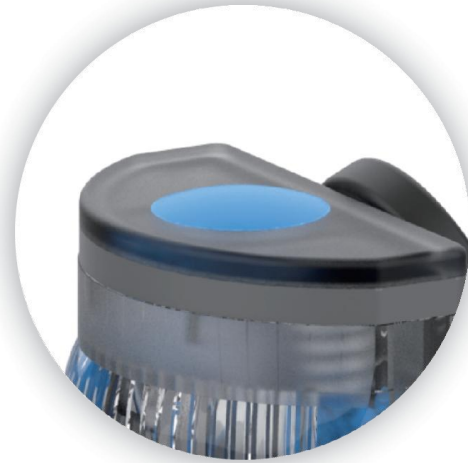

High performance LED
lamp beads, operating life
 $\geq 100,000$ hours

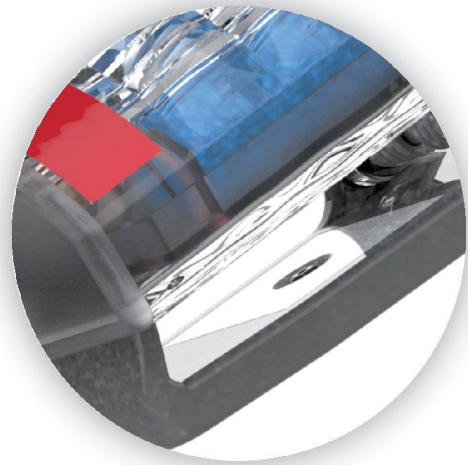
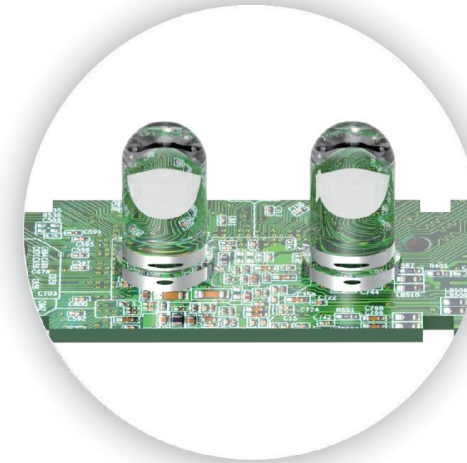

Strong magnetic suction

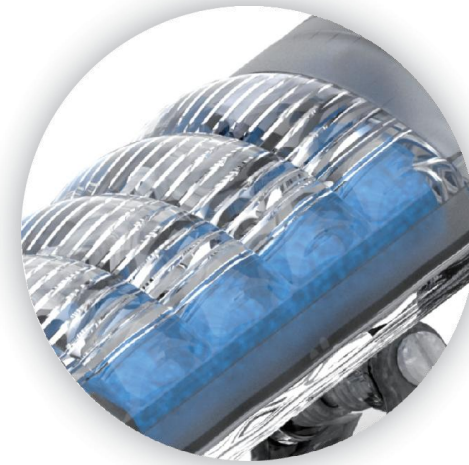

Polygonal spotlight
lamp chimney

High-strength
magnetic side clip



Reflective label, more
visible at night



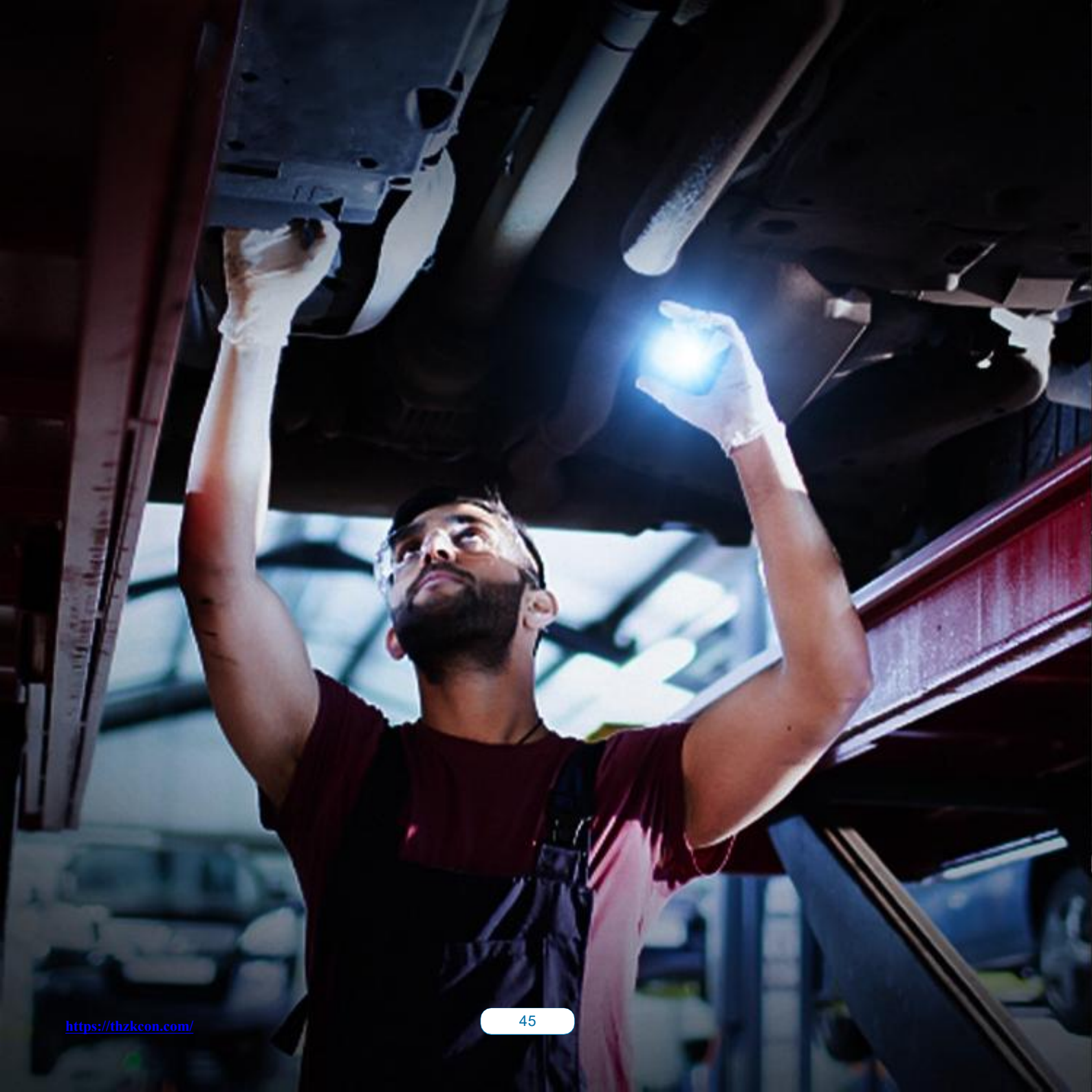

Flashlight Traffic Baton

High-light, long-range shot and easy to use, can be used as an emergency escape tool.





L9500A/R

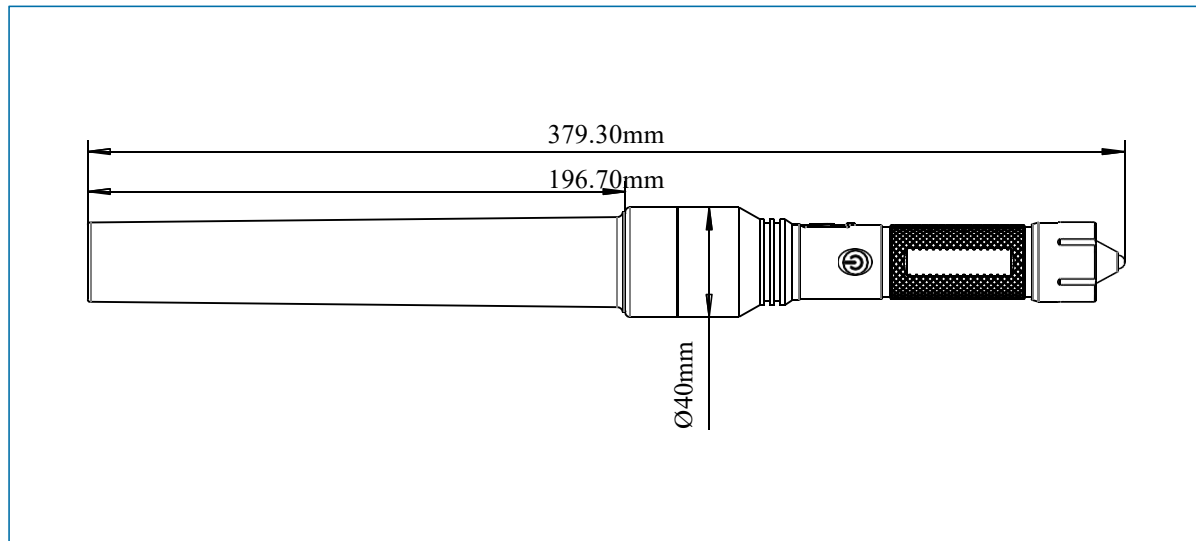

Specification

Part Number	L9500A	L9500R
Power	3PCS AAA	1PCS 18650
Size	φ40mm*379.30mm	
Material	Handle: Aluminum; Head: PC	
LED Color	○	
Tube Color	●	
Flash Frequency	7Hz	
LED Number	1pcs	
Item Weight	165g (batteries not included)	
Function	GLARE-LOW-FLASH	
Charging	/	TYPE C
Charging Power	/	5V-1A

L9510A / R

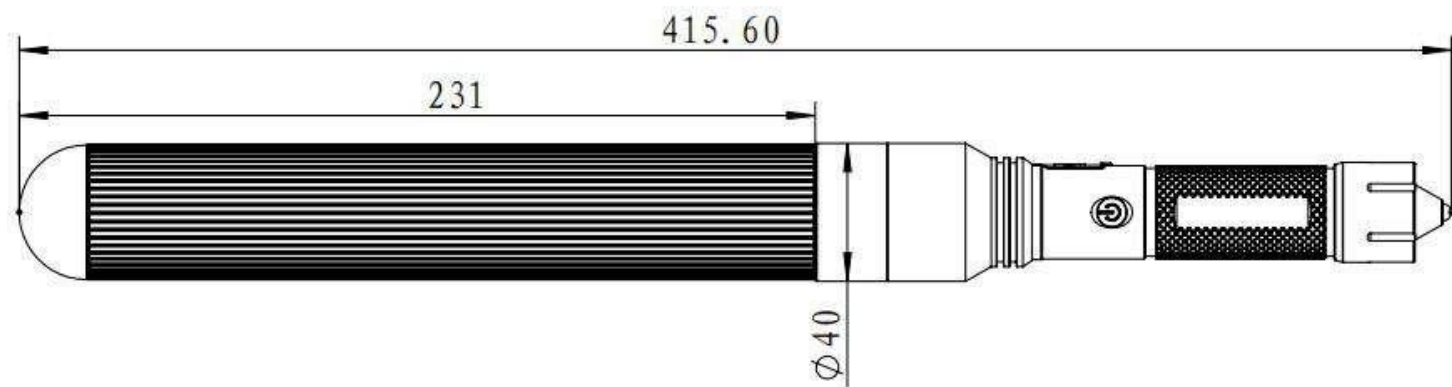

Specification

Part Number	L9510A	L9510R
Power	3PCS AAA	1PCS 18650
Size	φ40mm*415.60mm	
Material	Handle: Aluminum; Head: PC	
LED Color	○	
Tube Color	●	
Flash Frequency	7Hz	
LED Number	1pcs	
Item Weight	185g (batteries not included)	
Function	GLARE-LOW-FLASH	
Charging	/	TYPE C
Charging Power	/	5V-1A

Product Details

3W LED

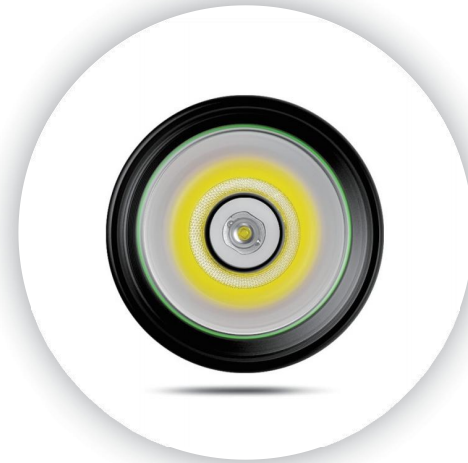

Type-C quick charged

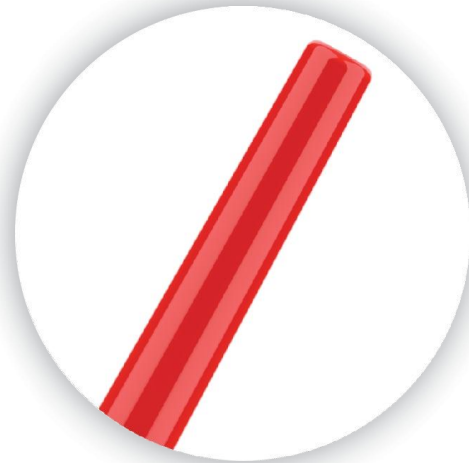

Anti-abrasive PC light tube



3pcs AAA and #18650 rechargeable optional

Safe hammer for emergency



Non-slip and anti-abrasive handle





DAY WAND

Drop-resistant, high and low-temperature resistant, ultra-lightweight, and easy to use.



Product Details



	product name	L9081 DAY WAND
	Weight	68g
	Color	Red
	Operating temperature	-30°C~80°C
	daily visibility	>1Km
	Package	1pcs/PE, 200pcs/box
	Packaging Information	470*360*450mm